

Panneaux VARIMAX

Les hauteurs et les largeurs des panneaux Varimax procurent les avantages d'un quadrillage extensible. Le nombre limité de tailles de panneaux facilite la planification et accélèrent la mise en place du coffrage.

- 5 largeurs de banches
- 5 hauteurs de banches
- 5 banches grand format

Pour chaque type de panneau et chaque taille, il y a deux options de revêtement:

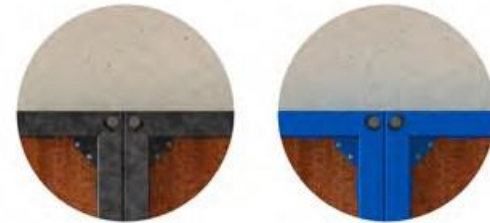

Finition
Galvanisation à
chaud

Finition
Peinture époxy
(RAL au choix)

PANNEAUX STANDARDS

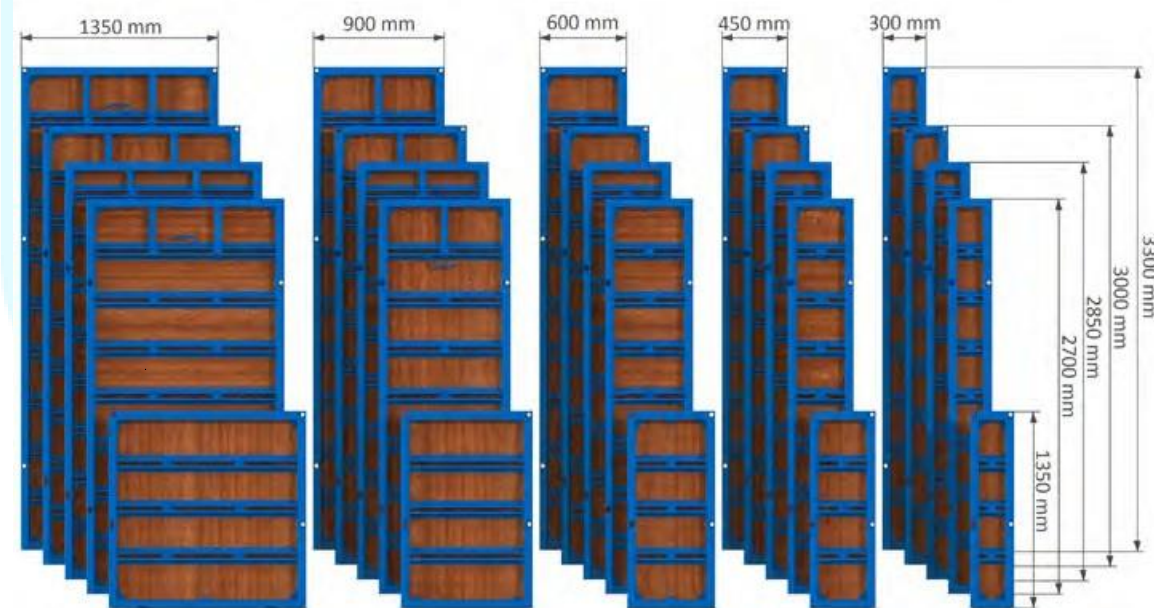

Deux options de profils sont disponibles:

Profil Varimax

Profil Varimax P

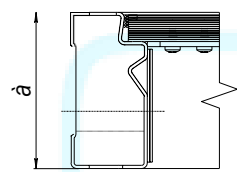

$a = 123 \text{ mm}$

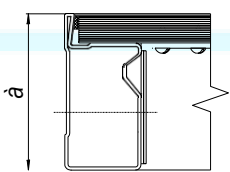

$a = 123 \text{ mm}$



Panneaux VARIMAX

PANNEAUX GRAND FORMAT

- Destinés à être utilisés pour des voiles grandes dimensions.
- Le nombre d'accessoires et de connecteurs est réduit.
- Peuvent s'installer verticalement ou horizontalement.

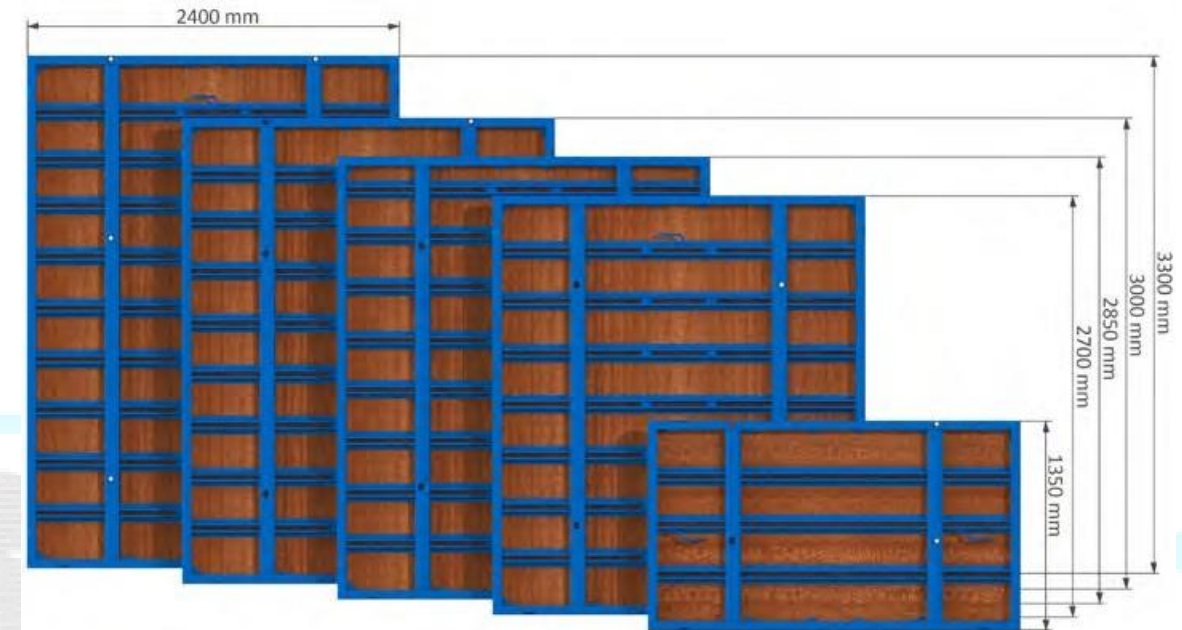

PANNEAUX POLYVALENTS

Une trame de perçages end ces panneaux particulièrement adaptés pour:

- Angles;
- Jonctions de voiles;
- Éléments terminaux;
- Poteaux.

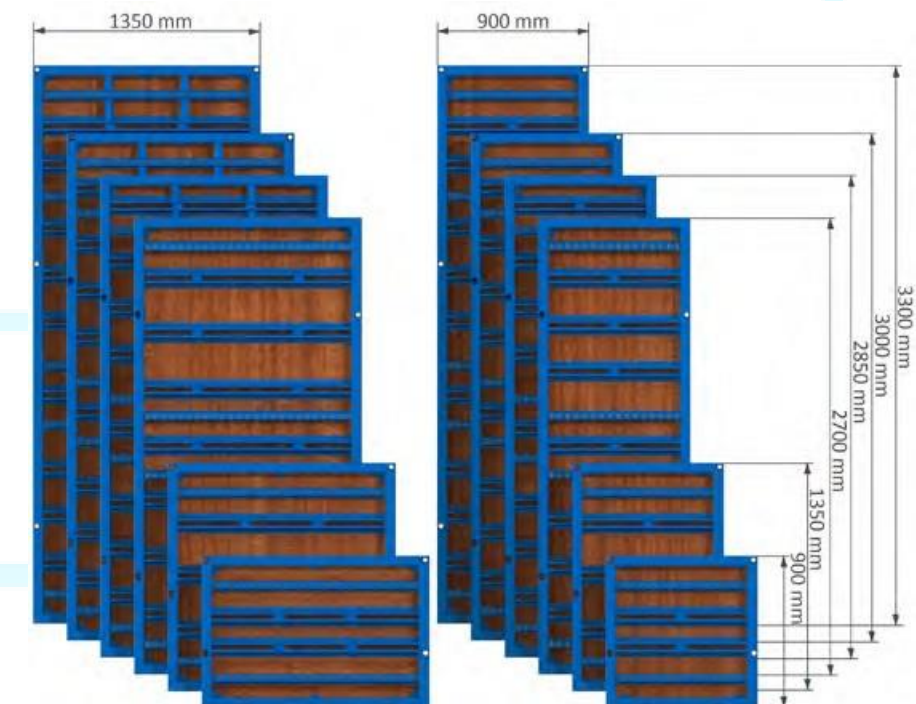

Jonction de panneaux VARIMAX

ASSEMBLAGE

Grâce à une rainure continue sur tout le profil de panneau, il est possible d'installer une pince

d'assemblage à l'endroit voulu, d'un seul coup de marteau. Cela permet un assemblage ultra-rapide sans outils spéciaux.

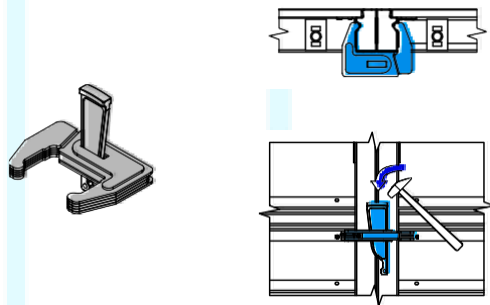

CÉLÈMENTS DE BLOCAGE

Sont destinées aux endroits où un coffrage ne peut être placé facilement. Elles sont remplies avec du bois de construction et fixées avec une pince d'alignement ajustable.

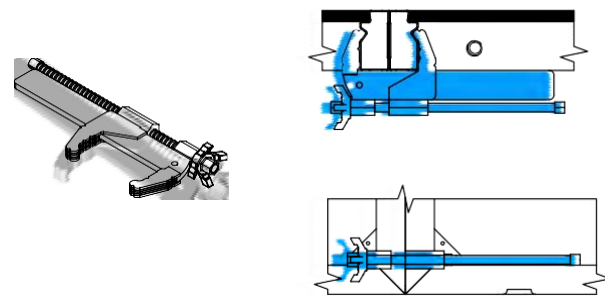

Jonction de panneaux VARIMAX

FIXATION

Les tiges d'ancrage de forme conique sur les panneaux permettent de faire tenir les ensembles

sur un angle d'un ou de deux côtés, et de les placer à des niveaux différents.

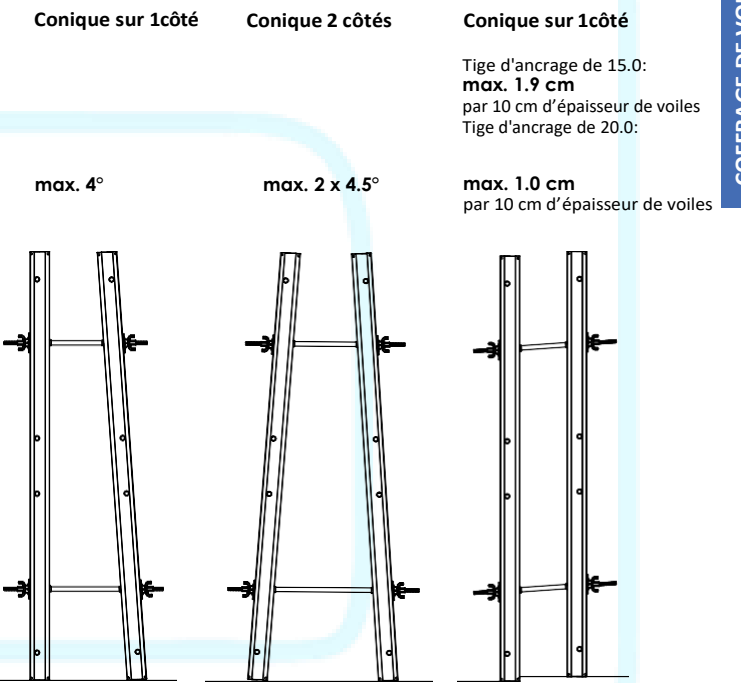
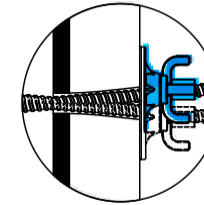

ANGLE DE DÉCOFFRAGE

L'angle de décoffrage Varimax a été spécialement conçu pour l'utilisation sur les coffrages de cages d'ascenseur. Elle permet de fermer ou d'ouvrir le coffrage en conformité avec les réglementations sur la protection contre les accidents, c'est à dire sans grue, simplement en actionnant des vérins de décoffrage. Elle peut ensuite être levée et réinstallée d'une seule pièce, économisant ainsi du temps de grutage. L'angle de décoffrage Varimax convient également pour une utilisation sur des pilastres et comme élément d'angle intérieur sur les coffrages de voiles.



EMPILEMENT VERTICAL



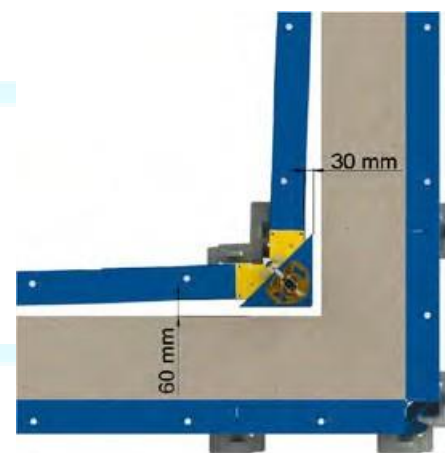
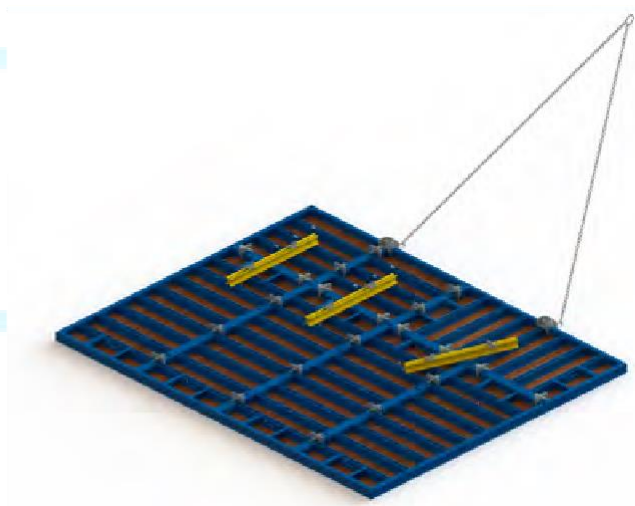



Les panneaux peuvent être aisément assemblés en banches groupées rigides de grande dimension en utilisant des filières et pinces de serrage pour être levées et mises en places par une grue.



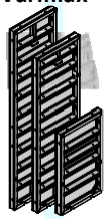
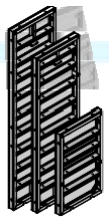

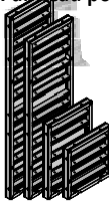
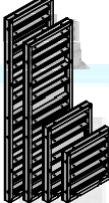

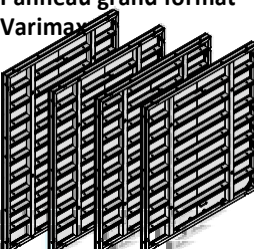
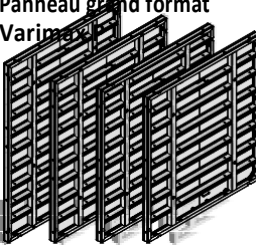

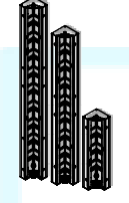
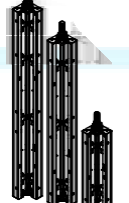

SALESBRIDGES

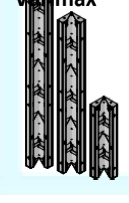
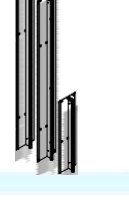

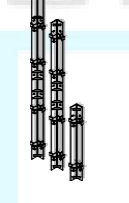
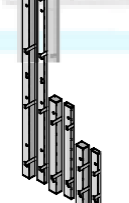

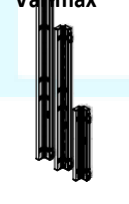
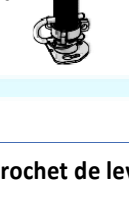

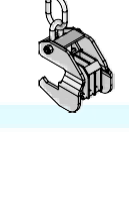
VARIMAX

VARIMAX

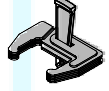

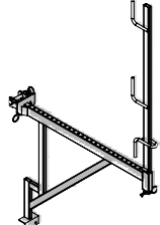
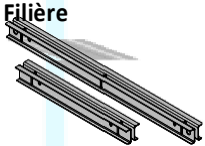
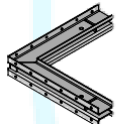
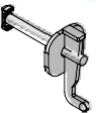

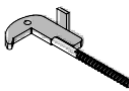
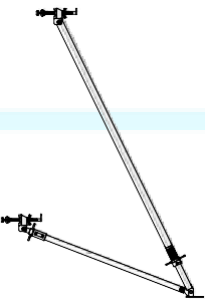

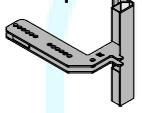







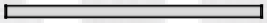

| Article | [kg] | Article no | Article | [kg] | Article no | | |
|--|---|------------|--|---|------------|--------|------------|
| Panneau standard Varimax  | 1.35x3.30m | 260,40 | 11 104 000 | Panneau standard Varimax P  | 1.35x3.30m | 276,41 | 15 104 000 |
| | 0.90x3.30m | 183,33 | 11 108 000 | | 0.90x3.30m | 180,34 | 15 108 000 |
| | 0.60x3.30m | 127,05 | 11 110 000 | | 0.60x3.30m | 132,47 | 15 110 000 |
| | 0.45x3.30m | 101,85 | 11 112 000 | | 0.45x3.30m | 110,27 | 15 112 000 |
| | 0.30x3.30m | 80,85 | 11 114 000 | | 0.30x3.30m | 88,10 | 15 114 000 |
| | 1.35x3.00m | 236,25 | 11 204 000 | | 1.35x2.70m | 235,20 | 15 404 000 |
| | 0.90x3.00m | 166,70 | 11 208 000 | | 0.90x2.70m | 141,54 | 15 408 000 |
| | 0.60x3.00m | 114,45 | 11 210 000 | | 0.60x2.70m | 109,62 | 15 410 000 |
| | 0.45x3.00m | 97,65 | 11 212 000 | | 0.45x2.70m | 93,56 | 15 412 000 |
| | 0.30x3.00m | 76,65 | 11 214 000 | | 0.30x2.70m | 68,85 | 15 414 000 |
| | 1.35x2.85m | 231,00 | 11 304 000 | | 1.35x1.35m | 115,03 | 15 504 000 |
| | 0.90x2.85m | 161,70 | 11 308 000 | | 0.90x1.35m | 91,35 | 15 508 000 |
| | 0.60x2.85m | 123,59 | 11 310 000 | | 0.60x1.35m | 65,53 | 15 510 000 |
| | 0.45x2.85m | 95,78 | 11 312 000 | | 0.45x1.35m | 50,24 | 15 512 000 |
| | 0.30x2.85m | 74,26 | 11 314 000 | | 0.30x1.35m | 39,49 | 15 514 000 |
| | 1.35x2.70m | 221,00 | 11 404 000 | | | | |
| | 0.90x2.70m | 143,82 | 11 408 000 | | | | |
| | 0.60x2.70m | 105,63 | 11 410 000 | | | | |
| | 0.45x2.70m | 86,42 | 11 412 000 | | | | |
| | 0.30x2.70m | 63,19 | 11 414 000 | | | | |
| 1.35x1.35m | 108,36 | 11 504 000 | | | | | |
| 0.90x1.35m | 88,04 | 11 508 000 | | | | | |
| 0.60x1.35m | 56,62 | 11 510 000 | | | | | |
| 0.45x1.35m | 46,40 | 11 512 000 | | | | | |
| 0.30x1.35m | 36,24 | 11 514 000 | | | | | |
| 1.35x0.90m | 54,00 | 11 604 000 | | | | | |
| 0.90x0.90m | 43,87 | 11 608 000 | | | | | |
| 0.60x0.90m | 36,90 | 11 610 000 | | | | | |
| 0.45x0.90m | 30,20 | 11 612 000 | | | | | |
| 0.30x0.90m | 23,60 | 11 614 000 | | | | | |
| |  | | | | | | |
| Panneau polyvalent Varimax  | 1.35x3.30m | 298,20 | 11 102 000 | Panneau polyvalent Varimax P  | 1.35x3.30m | 324,20 | 15 102 000 |
| | 1.35x3.00m | 281,40 | 11 202 000 | | 1.35x2.70m | 196,35 | 15 402 000 |
| | 1.35x2.85m | 268,28 | 11 302 000 | | 1.35x1.35m | 139,84 | 15 502 000 |
| | 1.35x2.70m | 258,62 | 11 402 000 | | 0.90x3.30m | 208,68 | 15 106 000 |
| | 1.35x1.35m | 128,63 | 11 502 000 | | 0.90x2.70m | 184,12 | 15 406 000 |
| | 1.35x0.90m | 95,80 | 11 602 000 | | 0.90x1.35m | 94,74 | 15 506 000 |
| | 0.90x3.30m | 218,40 | 11 106 000 | | | | |
| | 0.90x3.00m | 178,50 | 11 206 000 | | | | |
| | 0.90x2.85m | 166,95 | 11 306 000 | | | | |
| | 0.90x2.70m | 184,12 | 11 406 000 | | | | |
| 0.90x1.35m | 90,36 | 11 506 000 | | | | | |
| 0.90x0.90m | 67,20 | 11 606 000 | | | | | |
| |  | | | | | | |
| Panneau grand format Varimax  | 2.40x3.30m | 500,85 | 11 100 000 | Panneau grand format Varimax P  | 2.40x3.30m | 536,56 | 15 100 000 |
| | 2.40x3.00m | 435,60 | 11 200 000 | | 2.40x2.70m | 436,40 | 15 400 000 |
| | 2.40x2.85m | 472,95 | 11 300 000 | | 2.40x1.35m | 227,43 | 15 500 000 |
| | 2.40x2.70m | 407,40 | 11 400 000 | | 2.70x3.30m | 585,84 | 15 101 000 |
| | 2.40x1.35m | 212,32 | 11 500 000 | | 2.70x2.70m | 476,50 | 15 401 000 |
| |  | | | | | | |
| | | | Options disponibles: xx xxx 000 - Revêtement peinture poudre; xx xxx 100 - Galvanisé; xx xxx 200 - Galvanisé à chaud; Tailles personnalisées sur demande | | | | |

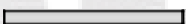
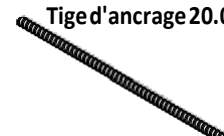
| Article | [kg] | Article no | Article | [kg] | Article no | | |
|---|---|------------|---|---|------------|------------|------------|
| Angle intérieur Varimax  | 0.30x3.30m | 121,80 | 11 710 000 | Angle de décoffrage Varimax  | 0.30x3.30m | 207,90 | 11 718 000 |
| | 0.30x3.00m | 114,17 | 11 720 000 | | 0.30x3.00m | 190,30 | 11 728 000 |
| | 0.30x2.85m | 108,47 | 11 730 000 | | 0.30x2.85m | 176,20 | 11 738 000 |
| | 0.30x2.70m | 103,49 | 11 740 000 | | 0.30x2.70m | 168,70 | 11 748 000 |
| | 0.30x1.35m | 51,90 | 11 750 000 | | 0.30x1.35m | 97,65 | 11 758 000 |
| | 0.30x0.90m | 36,07 | 11 760 000 | | | | |
| |  | | | | | | |
| Options disponibles: xx xxx 000 - Revêtement peinture poudre; xx xxx 200 - Galvanisé à chaud; Tailles personnalisées sur demande | | | Options disponibles: xx xxx 000 - Revêtement peinture poudre; xx xxx 200 - Galvanisé à chaud; Tailles personnalisées sur demande | | | | |
| Angle charnière intérieur Varimax  | 0.30x3.30m | 141,23 | 11 712 000 | Support de compensation Varimax  | 3.30m | 68,69 | 11 810 000 |
| | 0.30x3.00m | 129,15 | 11 722 000 | | 3.00m | 62,30 | 11 820 000 |
| | 0.30x2.85m | 120,44 | 11 732 000 | | 2.85m | 59,33 | 11 830 000 |
| | 0.30x2.70m | 116,55 | 11 742 000 | | 2.70m | 57,77 | 11 840 000 |
| | 0.30x1.35m | 61,36 | 11 752 000 | | 1.35m | 28,10 | 11 850 000 |
| | 0.30x0.90m | 41,16 | 11 762 000 | | | | |
| |  | | | | | | |
| Options disponibles: xx xxx 000 - Revêtement peinture poudre; xx xxx 200 - Galvanisé à chaud; Tailles personnalisées sur demande | | | Options disponibles: xx xxx 000 - Revêtement peinture poudre; xx xxx 200 - Galvanisé à chaud; Tailles personnalisées sur demande | | | | |
| Angle extérieur Varimax  | 3.30m | 60,69 | 11 714 000 | Rail de blocage Varimax  | 0.10x3.30m | 40,10 | 11 812 000 |
| | 3.00m | 54,50 | 11 724 000 | | 0m | 36,45 | 11 822 000 |
| | 2.85m | 51,98 | 11 734 000 | | 0.10x3.00m | 34,60 | 11 832 000 |
| | 2.70m | 49,35 | 11 744 000 | | 0.10x2.85m | 32,80 | 11 842 000 |
| | 1.35m | 24,26 | 11 754 000 | | 0.10x2.70m | 16,40 | 11 852 000 |
| | | | | | 0.10x2.70m | 11,39 | 11 862 000 |
| |  | | 0.10x1.35m | 29,80 | 11 814 000 | | |
| Options disponibles: xx xxx 000 - Revêtement peinture poudre; xx xxx 200 - Galvanisé à chaud; Tailles personnalisées sur demande | | | 0.10x0.90m | 27,12 | 11 824 000 | | |
| Angle charnière extérieur Varimax  | 3.30m | 64,68 | 11 716 000 | Vérin de décoffrage Varimax  | 3.71 | 11 942 100 | |
| | 3.00m | 58,83 | 11 726 000 | | | | |
| | 2.85m | 54,08 | 11 736 000 | | | | |
| | 2.70m | 52,88 | 11 746 000 | | | | |
| | 1.35m | 27,25 | 11 756 000 | | | | |
| | | | | | | | |
| |  | | | | | | |
| Options disponibles: xx xxx 000 - Revêtement peinture poudre; xx xxx 200 - Galvanisé à chaud; Tailles personnalisées sur demande | | | Options disponibles: xx xxx 000 - Revêtement peinture poudre; xx xxx 200 - Galvanisé à chaud; Tailles personnalisées sur demande | | | | |
| Crochet de levage LH-H-1t Varimax  | | 10,34 | 11 924 000 | | | | |
| | | | | | | | |

VARIMAX

| Article | [kg] | Article no | Article | [kg] | Article no |
|---|--------------------------------------|----------------------------------|---|-------|------------|
| Pince d'assemblage Varimax  | 3,90 | 11 902 100 | Fixation de panneaux Varimax  | 1,84 | 11 922 000 |
| Tendeur de compensation Varimax  | 6,00 | 11 904 100 | Ensemble console de service Varimax  | 13,28 | 11 926 100 |
| Filière  | 0,90m 1,50m | 11,35 18,85 | 11912000 11914000 | | |
| Rail de blocage d'angle  | 0,60x0,60m | 14,04 | 11 916 000 | | |
| Pince de serrage  | 1,49 | 11 918 100 | Etançon de banche 340  | 37,38 | 11 928 100 |
| Ancrage d'about Varimax  | 1,76 | 11 906 100 | Etançon de banche 540  | 56,91 | 11 930 100 |
| Boulon d'assemblage  | 10-16 10-25 | 0,63 0,79 | 11908100 11910100 | | |
| Equerre de transition  | 12 /18 12/21 10/18 10/21 | 18,70 19,05 17,90 18,25 | 23500100 23502100 23504100 23506100 | | |

VARIMAX

| Article | [kg] | Article no | Article | [kg] | Article no |
|---|---|--------------|--|-------|---|
| Etançon grande hauteur  |  | | Equerre d'ancrage Varimax  | 1,30 | 11 920 000 |
| Tête de vérin  | 3,48 | 11932100 | Tube synthétique 22mm  | 2,00m | 0,36 99 100 400 |
| Unité de vérin sans sabot  | 36,62 | 11934000 | Cône universel 22 mm  | 0,005 | 99 102 400 |
| Tube intermédiaire 3.70 m  | 78,75 | 11936000 | Tige d'ancrage 15.0 mm  | 0,80 | 92050300 1,20 92075300 1,60 92100300 2,00 92125300 2,40 92150300 2,80 92175300 3,20 92200300 3,60 92225300 4,00 92250300 4,40 92275300 4,80 92300300 9,60 92600300 |
| Tube intermédiaire 2.40 m  | 54,13 | 11938000 | Tige d'ancrage 20.0 mm  | 1,20 | 93050300 1,80 93075300 2,40 93100300 3,00 93125300 3,60 93150300 4,20 93175300 4,80 93200300 5,40 93225300 6,00 93250300 6,60 93275300 7,20 93300300 |
| Unité de vérin avec sabot  | 43,81 | 11940000 | Écrou étoilé  | 15 | 0,40 95 206 100 |
| Platine avec écrou pivotant  | 15 20 | 1,22 2,10 | 95 200 100 95 202 100 | | |
| Écrou hexagonal  | 15 | 0,37 | 95 208 100 | | |
| Plaquette d'appui  | 0,86 | 95 210 100 | Bouchon de fermeture Varimax  | 0,008 | 11 990 400 |
| | | | Bouchon de fermeture universel  | 0,005 | 11 992 400 |